

# Dilations #2

Name: \_\_\_\_\_

Date: \_\_\_\_\_

Period: \_\_\_\_\_

Dilate each shape from the origin according to the directions. Make sure you write the coordinates of the pre-image, show your work of how you diluted each ordered pair as well as the coordinates to the image.

1. Dilate by a Scale Factor of 4

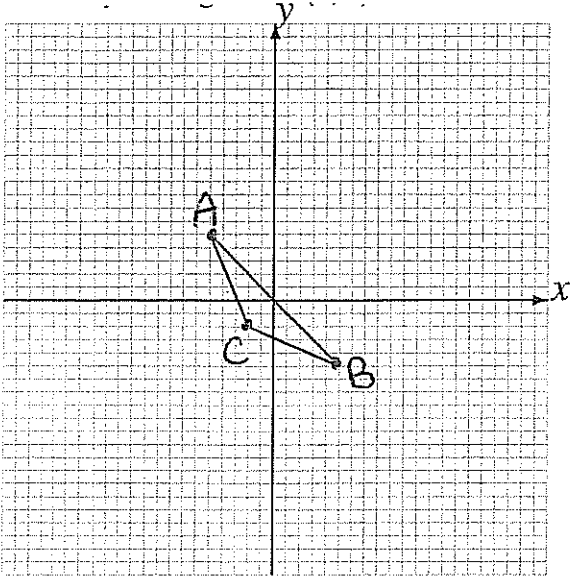

2. Dilate by a Scale Factor of  $\frac{1}{3}$

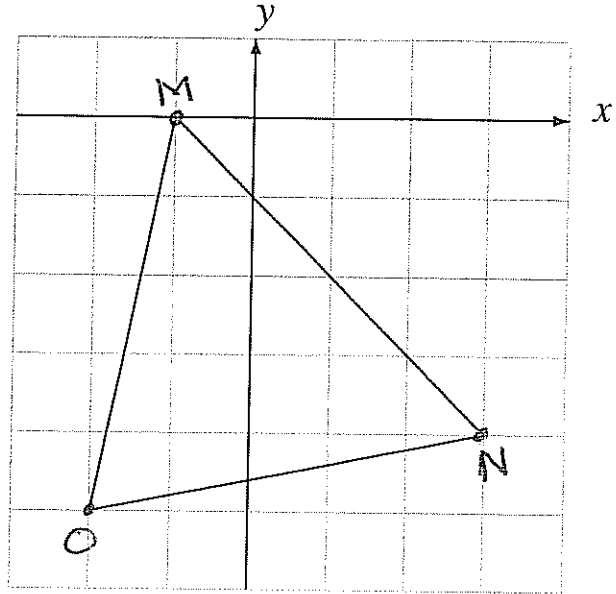

4. Dilate by a Scale Factor of 3

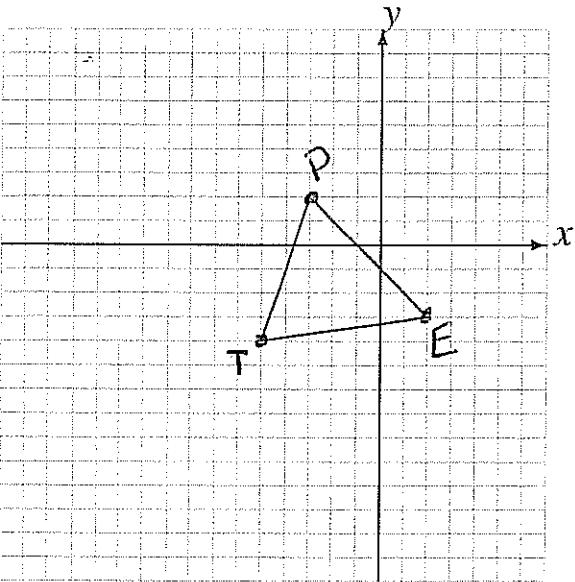

5. Dilate by a Scale Factor of  $\frac{1}{4}$

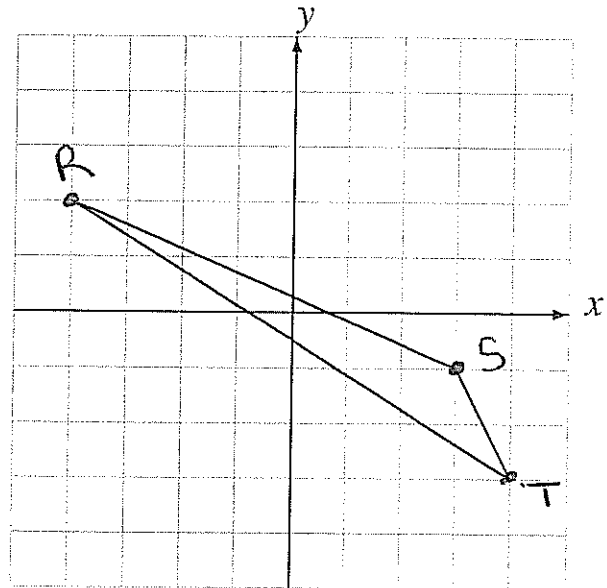

6. Dilate by a Scale Factor of 2

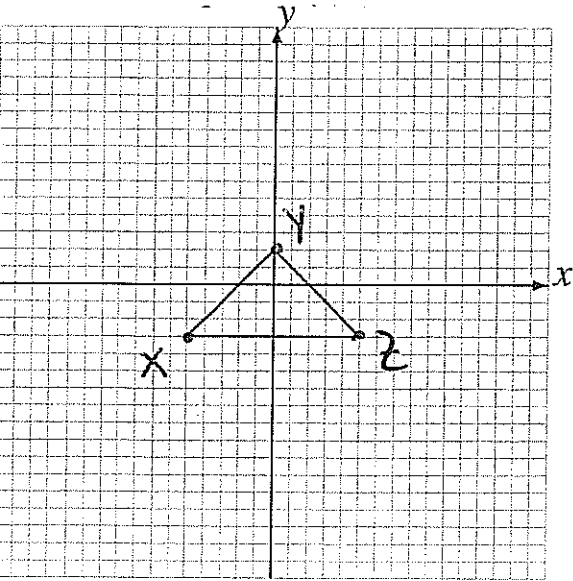

7. Dilate by a Scale Factor of 4

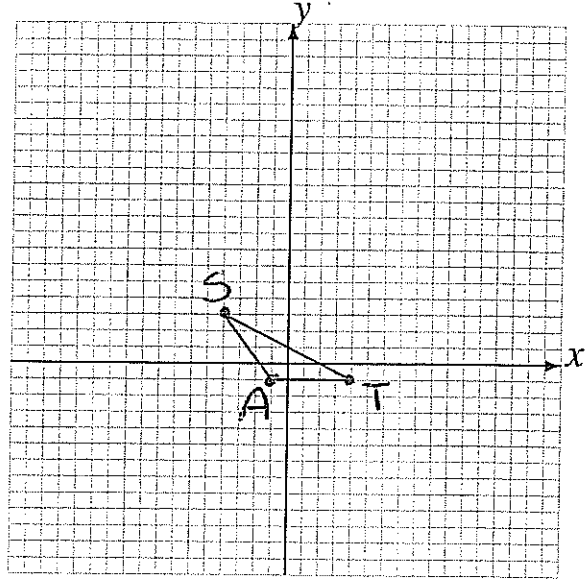

8. Dilate by a Scale Factor of  $\frac{1}{2}$

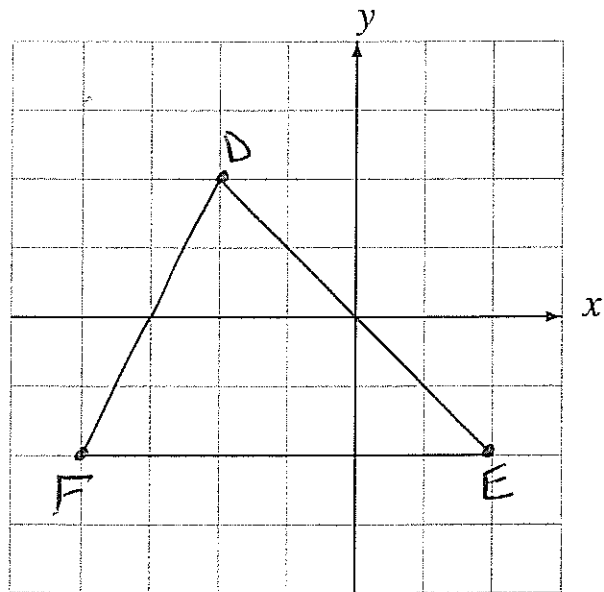

9. Dilate by a Scale Factor of  $\frac{1}{3}$

